

HCD – Airfoil Control Damper

Model: HCD-75

The Holyoake HCD-75 is a precision made volume and pressure control device, with extremely low leakage when closed. It provides better control of an air stream in a size between an OBD3 and the HCD-150. Like the HCD-150, the HCD-75 offers low resistance when open.

Standard Construction

- Frame:** 6063 T5 extruded aluminium with square cut ends, mechanically joined with screws tapped into screw pipes.
- Blades:** 6063 T5 three cavity extrusion providing a full airfoil section.
- Linkage:** Concealed in frame, with stainless steel cranks and link pins and aluminium control bars.
- Axles:** Hexagonal stainless steel.
- Bearings:** Two piece moulded glass reinforced nylon, pressed into frame, with the outer sleeve locked with locating ribs (-8° to 220°C).
- Seals:** Blade edge & Jamb: Extruded EPDM, (0°C to 80°C). Side Seal: Flexible (convex) aluminium.
- Control Shaft:** **[Standard]:** Round Drive Shaft 120 mm, complete with Motor Mounting Plate - HCD32 Kit (HCD23 & 28).
[Optional]:
[1] Hex Extension Shaft 23, 44, 93, or 300 mm, complete with Motor Mounting Plate - HCD 25, 26, 22, or 27, with a HCD 23.
[2] Hex Extension Shaft (93 mm) complete with Quadrant Arm and Plate – HCD31 Kit (HCD22/23/24).
- Blade Rotation:** **[Standard]:** Opposed
[Optional]: Parallel (specify if required).
- Finish:** Mill standard, anodized and powercoat options available.
- Minimum Size:** 150 mm wide and 95 mm high (Air Stream).
- Maximum Size:** 950 mm wide and 898 mm high (Air Stream).
- General:** The specified size is the duct airstream size. The actual overall size is the airstream size plus 50 mm.

Special Construction Options

Smoke Damper: High Temperature HCD75-ET version available suitable for smoke applications see page 328H - 329H.

For other features please contact your local Holyoake Branch.

Installation

Dampers must be installed square and free from racking. Typically the method of driving the damper depends on its application. Where the actuator is to be located externally, specify Round Drive Shaft 120 mm. For manual control, use Hex Extension Shafts, Quadrant Arm and Plate.

Motorised HCD-75 dampers must not be installed with the axles vertical.

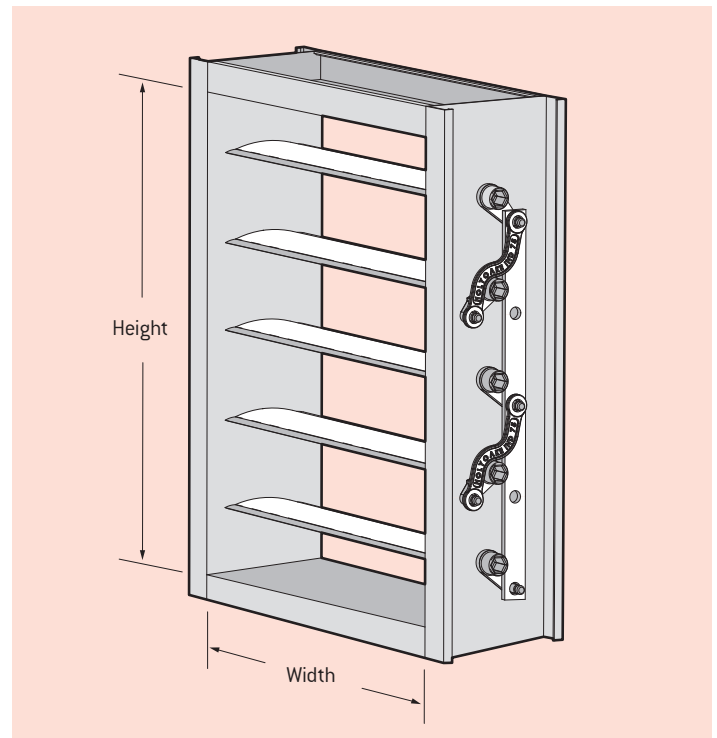
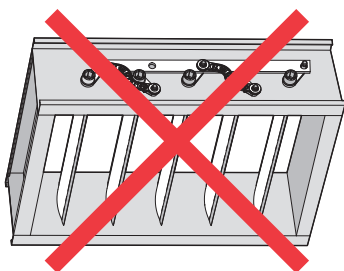

Duct Mounting

The HCD-75 has been specifically designed to be installed using 25 mm proprietary duct flanging systems.

This means that the damper can be installed in exactly the same way as a piece of flanged duct.

This way of mounting the HCD-75 provides an easy installation method and maintains the maximum amount of free area, which is especially important as the HCD-75 control damper is more likely to be used in smaller sized ducts. The HCD-75 can also be mounted inside a duct in much the same way as an HCD-150 Standard Channel damper.

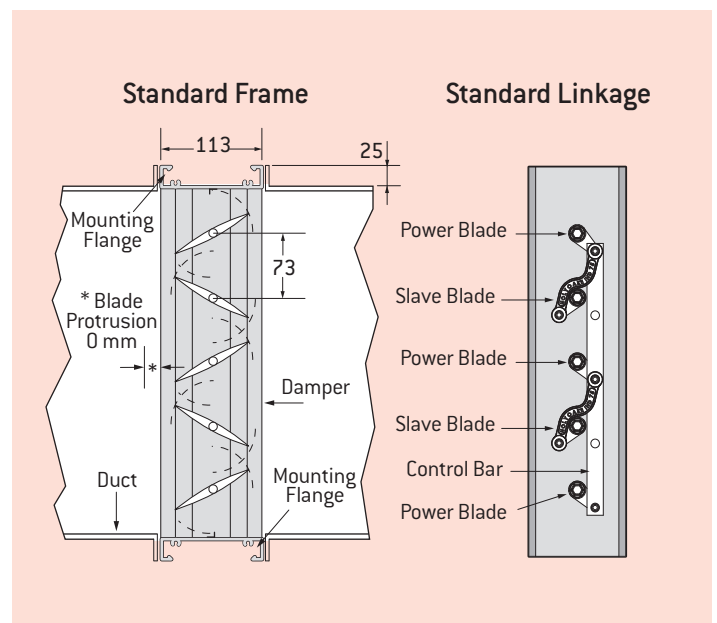

The location to be fitted with either a locking quadrant, or motorised drive shaft **must** be a "power blade" axle on the linkage side of the damper, i.e. every second shaft on opposed blade dampers, or every blade on parallel blade dampers.

Model: HCD-75 Pressure Drop Data - Flange Surround

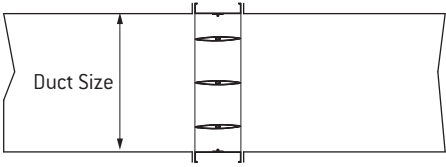

		Area Factor Table																
Duct Height (mm)	No. of Blades	Duct Width (mm)																
		150	200	250	300	350	400	450	500	550	600	650	700	750	800	850	900	950
95	1	140.5	105.4	84.3	70.2	60.2	52.7	46.8	42.1	38.3	35.1	32.4	30.1	28.1	26.3	24.8	23.4	22.2
168	2	62.4	46.8	37.4	31.2	26.7	23.4	20.8	18.7	17.0	15.6	14.4	13.4	12.5	11.7	11.0	10.4	9.8
241	3	40.1	30.1	24.0	20.0	17.2	15.0	13.4	12.0	10.9	10.0	9.2	8.6	8.0	7.5	7.1	6.7	6.3
314	4	29.5	22.1	17.7	14.8	12.7	11.1	9.8	8.9	8.1	7.4	6.8	6.3	5.9	5.5	5.2	4.9	4.7
387	5	23.4	17.5	14.0	11.7	10.0	8.8	7.8	7.0	6.4	5.8	5.4	5.0	4.7	4.4	4.1	3.9	3.7
460	6	19.3	14.5	11.6	9.7	8.3	7.3	6.4	5.8	5.3	4.8	4.5	4.1	3.9	3.6	3.4	3.2	3.1
533	7	16.5	12.4	9.9	8.2	7.1	6.2	5.5	4.9	4.5	4.1	3.8	3.5	3.3	3.1	2.9	2.7	2.6
606	8	14.4	10.8	8.6	7.2	6.2	5.4	4.8	4.3	3.9	3.6	3.3	3.1	2.9	2.7	2.5	2.4	2.3
679	9	12.7	9.6	7.6	6.4	5.5	4.8	4.2	3.8	3.5	3.2	2.9	2.7	2.5	2.4	2.2	2.1	2.0
752	10	11.4	8.6	6.9	5.7	4.9	4.3	3.8	3.4	3.1	2.9	2.6	2.5	2.3	2.1	2.0	1.9	1.8
825	11	10.4	7.8	6.2	5.2	4.5	3.9	3.5	3.1	2.8	2.6	2.4	2.2	2.1	1.9	1.8	1.7	1.6
898	12	9.5	7.1	5.7	4.8	4.1	3.6	3.2	2.9	2.6	2.4	2.2	2.0	1.9	1.8	1.7	1.6	1.5

[All dimensions assume the duct size is the airstream size of the damper].

To determine the pressure drop through a fully open HCD-75 use the following procedure:

1. Find the Area Factor from the table above, enter Duct Width and Height.
2. Determine the Conversion Velocity (CV) by multiplying the Area Factor by the air flow in m³/s [CV = Area Factor x m³/s].
3. Enter the pressure drop chart below with the Area Factor and establish the intersection with the Conversion Velocity (CV) line just determined.

Read the pressure drop (Pa) on the left hand side of the chart.

Note: Interpolations while not precise are adequate for most calculations.

Example:

Find the pressure drop across a 600 mm wide x 606 mm high model HCD-75 with a flange surround (Airstream Size), passing 2.8 m³/s.

1. From the table using the interpolation, the Area Factor is 3.6.
2. CV = 2.8 x 3.6 = 10.
3. From the chart below, the pressure drop reads 13 Pa.

Guide Product Weights	
HCD 75 Airfoil Flanged	Approximate Weight in Kg
300 x 200	2.39
500 x 200	3.16

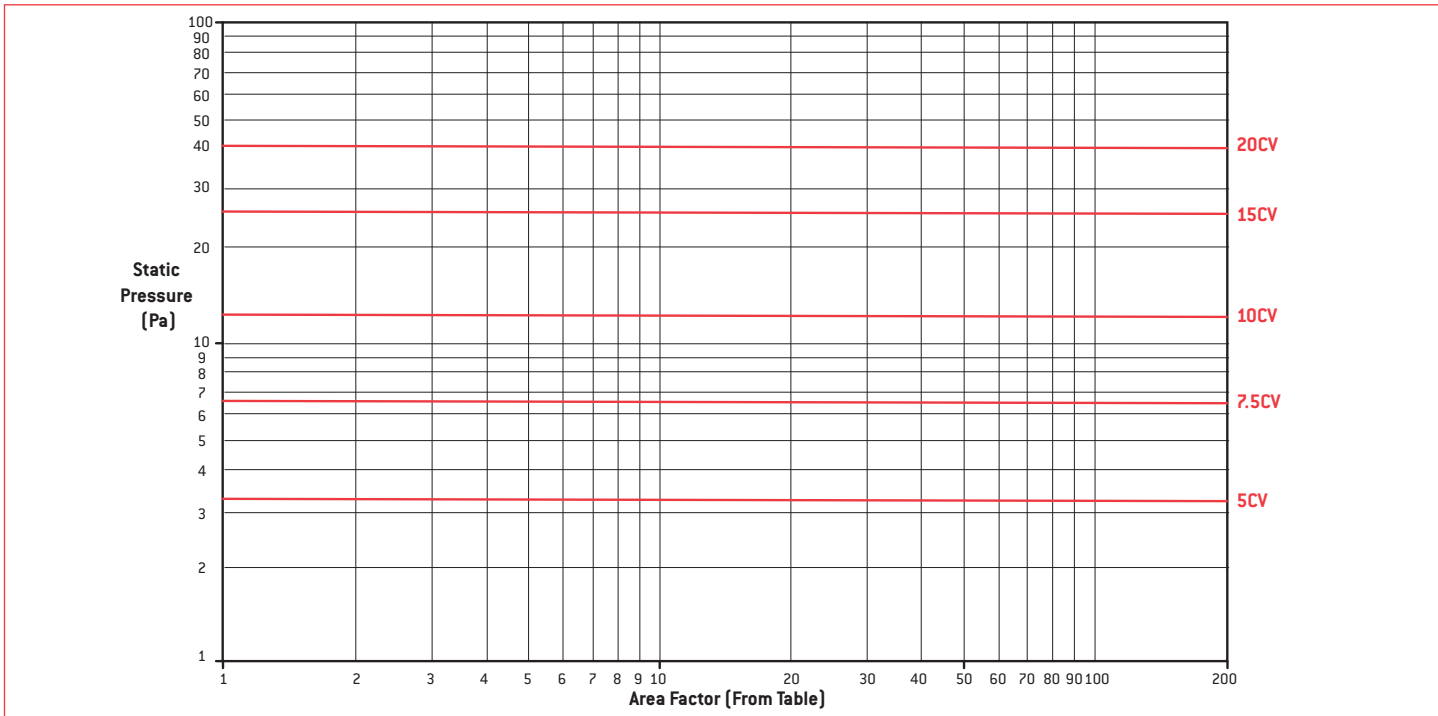

Notes

1. Static Pressure and Conversion Velocities are for air density of 1.2kg/m³.
2. Pressure drop data is for dampers tested with ductwork on both the up and downstream sides. These values need to be suitably increased where dampers are mounted with ductwork on one side only, or when mounted onto plenum walls. (Refer to SMACNA, or ASHRAE system design guides).
3. Data is for the specific sizes in the Area Factor Table. For other sizes use the next size down and make a proportional adjustment based on the approximate increase in free area.

HCD – Performance Data

Model: HCD-75 Leakage Data

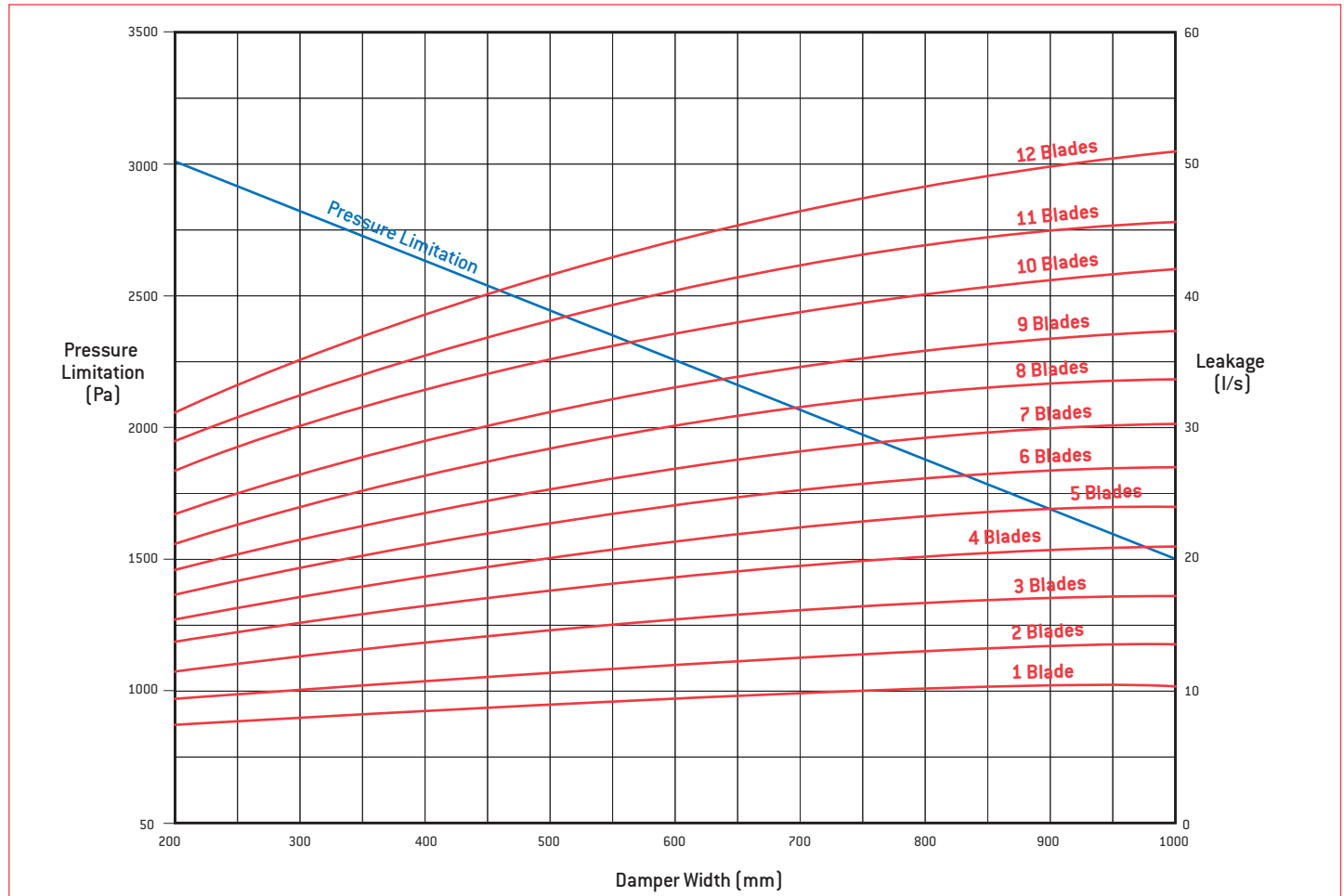

Leakage through a Closed HCD-75

Example:

To determine the leakage through a 600 mm wide x 444 mm high (5 bladed) damper at 1500 Pa ΔP .

- Enter the graph above at 600 mm width and read the intersection at the 5 blade line. Read the right hand side of the chart at 21 l/s.
- Read the leakage correction factor for 600 mm width and 1500 Pa from the table below = 1.
- Calculate leakage as $21 \times 1 = 21$ l/s.

Pressure Limitations on a Closed HCD-75

Example:

To establish pressure differential limitations for a damper with 600 mm long blades.

- Enter the graph above at 600 mm damper width.
- Read the intersection with the 'Pressure Limitation' line at the left hand side of the chart as 2250 Pa.

For ΔP 's other than 1.5k Pa, Use table below.

LEAKAGE CORRECTION FACTOR												
ΔP (Pa)	250	500	750	1000	1250	1500	1750	2000	2250	2500	2750	3000
Width												
200	0.38	0.58	0.68	0.80	0.91	1.00	1.06	1.06	1.06	1.10	1.21	1.40
400	0.38	0.58	0.68	0.80	0.91	1.00	1.06	1.06	1.06	1.10		
600	0.38	0.58	0.68	0.80	0.91	1.00	1.06	1.06	1.06			
800	0.38	0.60	0.66	0.76	0.91	1.00	1.06					
1000	0.38	0.60	0.66	0.76	0.86	1.00						

Notes

- Leakage is frequently specified as a percentage of maximum design flow. Typically full flow velocity on the above example would be 5 m/s, which would require volumetric flow of $5 \times 0.6 \times 0.444 = 1332$ l/s. Leakage would in this case be $(21 \times 100) / 1332 = 1.58\%$.
- Above leakage figures are based on a minimum closing torque of 2.4 Nm.
- Pressure limitations established by the above graph are intended to limit deflection on the longest blade (1000 mm) to 7 mm. Deflections for 800 mm or shorter blades, at higher pressure differentials, will be substantially less.

Standard Drive & Coupling Components

Standard Hardware

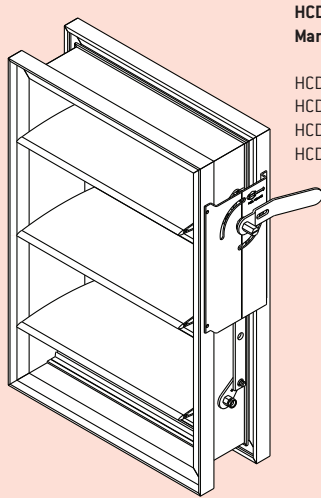

HCD-31 KIT
Manual Quadrant

HCD-02
HCD-22.36
HCD24
HCD16

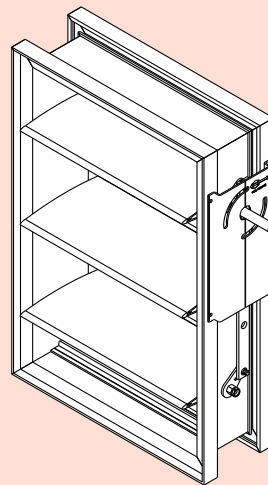

HCD-32 KIT
Actuator

HCD-02
HCD-01.120
HCD-16



HCD-22
Hex Drive Shaft
36mm or 90mm



HCD-01
Actuator Drive Shaft
60mm or 120mm

HCD-18
Slotted Crank Arm
12.5 mm Hole

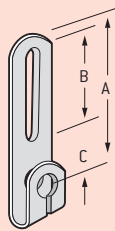

HCD-19
As Above with
25 mm Hole

	A	B	C
HCD 18	92	67	15
HCD 19	142	79	52

HCD-09
Standard Jackshaft
Bearing (25.4 mm)

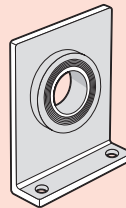

HCD-07
Standard Jackshaft
Link Arm
25.4 mm Dia



HCD-17
Control Arm
& Swivel

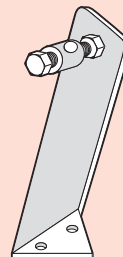

HCD-15
Coupler Bracket Assembly

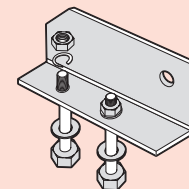

HCD-20
Swivel



Component	Description	Component	Description
HCD31	Manual Quadrant Kit includes HCD02, HCD22.36, HCD24, HCD16	HCD15	Coupler Bracket Assembly
HCD32	Actuator Kit includes HCD02, HCD01, HCD16	HCD16	Two Piece Hex Axle Bearing [-8 - 220°C]
HCD01	Round Actuator Drive Shaft 60, 120mm	HCD1602	Two Piece Round Axle Bearing [-8 - 220°C]
HCD02	Aluminium bracket for manual or actuated operation of damper	HCD17	Control Arm and Swivel
HCD04	Hex Coupler 29, 47mm	HCD18	Slotted Crank Arm 12.7mm Hole
HCD05	Tie Rod Arm	HCD19	Slotted Crank Arm 25.4mm Hole
HCD06	Tie Rod Bearing	HCD20	Swivel
HCD07	Standard Jackshaft Link Arm 25.4mm Dia	HCD21	8mm Stainless Steel Rod
HCD08	Mini Jackshaft Link Arm 12.7mm Dia	HCD22	Hex Manual Quadrant Drive Shaft 36,90mm
HCD09	Standard Jackshaft Bearing 25.4mm	HCD24	Manual Crank Arm
HCD10	Mini Jackshaft Bearing 12.7mm	HCD24EXT	PRD Counter Weight Arm
HCD11	25.4 x 1.8mm Stainless Steel Tubing	HCD34	One Piece Round Linkage Bearing [-8 - 220°C]
HCD11A	12.7 x 1.2mm Stainless Steel Tubing	HCD35	Manual Quadrant for 1/2" Shaft
HCD12	Stainless Steel Split Pin	HCDSSWIRECLIP	HCD Stainless Steel Wire Clip
HCD13E	Stainless Steel Axle & Crank	HCD150LINKARM	Aluminium Link Arm to suit HCD150
HCD13F	Stainless Steel Axle & Crank (Opposite Hand)	HCD75LINKARM	Aluminium Link Arm to suit HCD75
HCD13G	Stainless Steel Plain Hex Axle		

HBD & HCD

Product Ordering Key and Suggested Specifications

HBD-155

Holyoake
Balancing
Dampers with
155 mm
Aluminium
Blades

**OPPOSED
PARALLEL**

Blade Rotation:
Opposed (Standard)
Specify Parallel

W x H

Nominal
Duct
Size

CONTROL

Quadrant Arm and Plate.
Round Drive Shaft 120 mm.
Hex Ext Shaft,
(23, 44, 93 or 300 mm).

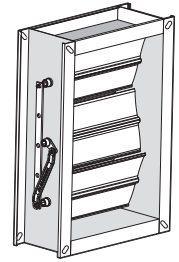

Balancing Dampers shall be of extruded aluminium construction. Frames shall be suitable for duct flange mounting. Blades shall be fixed to 11 mm hexagonal shafts held by two piece acetal self lubricating bearings, with outer shells fluted to prevent rotation.

Linkages shall be out of the airstream. The damper may be furnished with a manual locking quadrant arm, a round shaft and plate, or a hexagonal shaft and plate, suitable for actuator mounting.

All shall be type HBD-155 as manufactured by Holyoake.

**HCD-75
HCD-150**

Holyoake
Control
Dampers
with 75 or
150 mm
aluminium
airfoil blades.

**CHANNEL
LOW PROFILE CHANNEL
FLANGE SURROUND**

Frame
Style

**OPPOSED
PARALLEL**

Blade Rotation:
**Opposed
(Standard)** Specify
Parallel

W x H

Nominal
Duct
Size

CONTROL

Quadrant Arm and Plate.
Round Drive Shaft 120mm.
Hex Ext Shaft,
(23, 44, 93, or 300 mm).

**SPECIAL
CONSTRUCTION
OPTIONS**

For smoke damper see
page 328H - 329H

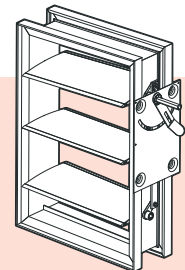

Volume Control Dampers shall be low leakage type extruded aluminium construction, with single piece airfoil blades, fitted with self inflating edge seals. Blades shall be fixed to 11 mm hexagonal shafts, held by two piece acetal self lubricating bearings, with outer shells fluted to prevent rotation. Frames shall be suitable for either internal fixing within ductwork, or external duct flange mounting and shall be fitted with flexible aluminium side seals. Linkages shall be out of the airstream. Leakage shall be no greater than 0.04 m³/s/m² at 1500 Pa Δp, or typically 0.45 % of full flow (at 5 m/s) with 500 Pa Δp. The damper may be furnished with a manual locking quadrant arm, a round shaft and plate, or a hexagonal shaft and plate, suitable for actuator mounting.

All shall be type HCD-75, or HCD-150, as manufactured by Holyoake.

HCD-225

Holyoake
Heavy Duty
Control
Dampers
with 225 mm
Airfoil Blades

PARALLEL

Blade Rotation
(No Opposed
Option)

W x H

**Nominal
(Overall Size)**

CONTROL

Electric Motor,
Pneumatic Actuator,
(Further discussion
required with local
Holyoake branch).

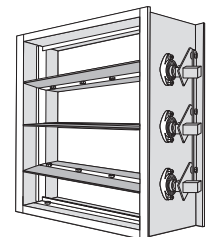

Heavy Duty Volume Control Dampers shall be constructed from extruded aluminium. Frames shall be suitable for duct flange mounting and be 6 mm thick. Blades shall be Parallel Airfoil 3 mm thick, with internal strengthening and fitted with externally mounted Heavy Duty Spherical Ball Bearings. Axle crank plates shall be 55 x 6 mm mild steel plate, with brass bearings; mounted outside of the airstream, providing a robust, long lasting operating mechanism, able to handle high turbulence/pressure and velocity. The damper shall be available with a range of control options to suit specialist applications.

All shall be type HCD-225 as manufactured by Holyoake.